

Name.....Adm No:.....

Candidate's Signature

Date:

233/1
PHYSICS 1
PAPER 1
THEORY
TIME: 2 HOURS

2017

FORM THREE

232/1
Physics
Paper 1
2 hours

INSTRUCTIONS TO THE CANDIDATES:

- Write your **name and admission number** in the spaces provided above.
- Answer **all** the questions both in section **A** and **B** in the spaces provided below each question
- All workings **must** be clearly shown; marks may be awarded for correct steps even if the answers are wrong.
- *Mathematical tables and non programmable silent electronic calculators may be used.*

(Take acceleration due to gravity $g = 10\text{ms}^{-2}$ Density of water 1g/m^{-3})

For examiners use only

SECTION	QUESTION	MAXIMUM SCORE	CANDIDATE'S SCORE
Section A	1-12	25	
Section B	13	13	
	14	06	
	16	12	
	17	13	
	18	11	
	TOTAL	80	

This paper consists of 9 printed pages. Candidates should check to ascertain that all pages are printed as indicated and that no questions are missing.

SECTION A (25 MKS)

Answer all questions in the spaces provided.

1. State one factor that would affect surface tension of pure water in a beaker of water. (1 mark)

.....

2. Use the information below to answer questions that follow.
In an experiment to determine the density of a liquid, the following readings were made.
Mass of empty density bottle = 20g
Mass of bottle filled with water = 70g
Mass of bottle filled with a liquid = 695g

- (a) Find the density of the liquid, given that density of water is 1000kgm^{-3} . (3marks)

- (b) Find the mass of the liquid. (3marks)

3. Explain why water does not wet a waxed glass surface. (1 mark)

.....
.....

4. Give a reason why mercury is preferred for use in a thermometer. (1 mark)

.....

5. The figure below shows a U-tube connected to gas supply containing liquids L1 and L2 of densities 1.8gcm^{-3} and 0.8gcm^{-3} respectively in equilibrium.

Given that $h_1 = 8\text{cm}$, $h_2 = 10\text{cm}$ and atmospheric pressure is $1.02 \times 10^5\text{Pa}$. Determine the gas pressure. (3 marks)

6. Explain why gases have larger intermolecular distances than solids. (1 mark)

.....

7. The figure below shows an instrument used to measure atmospheric pressure.

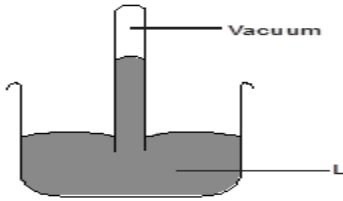

- (a) Name the instrument. (1 mark)

- (b) Name the liquid marked L. (1 mark)

8. A uniform rod of length 4m and mass of 4kg is pivoted at 3.6m mark. The rod is held horizontal with a vertical rope at the 4m mark, as shown in the figure below.

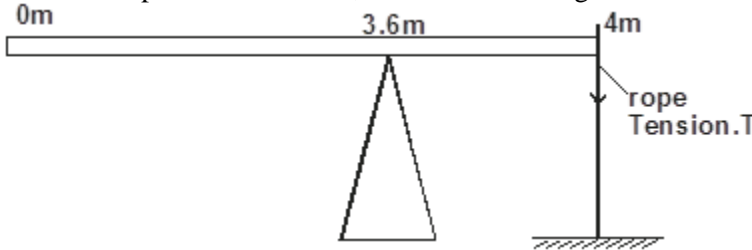

- Calculate the tension, T in the rope (Take $g = 10\text{N/kg}$). (3 marks)

9. The figure below shows an athlete lifting weights while standing with the feet apart.

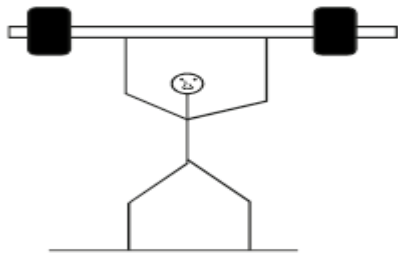

- Explain why standing with the feet apart improves the athlete's stability. (1 mark)

.....

10. The figure below shows parts A, B and C of a glass tube.

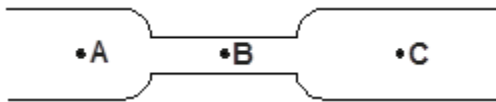

State with reason the part in the tube in which the pressure will be lowest when air is blown through the tube from A towards C. (2 marks)

.....
.....

11. State how the pressure in a moving fluid changes when the velocity of the fluid increases. (1 mark)

.....
.....

12. The spring is fitted with a scale pan as shown in the figure below and the pointer points to the 30cm mark on the scale. When some sand is placed in the pan the pointer points to 15cm mark.

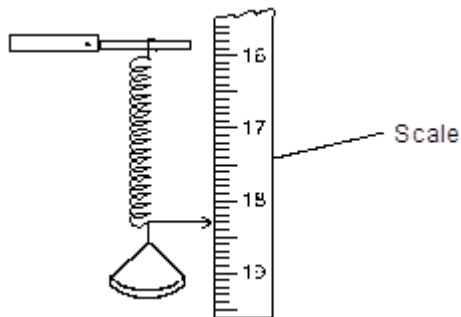

When a 20g mass is placed on top of the sand the pointer points to 5.0cm mark.

a) What extension is produced by the sand?

b) What extension is produced by the 20g mass?

c) What is the mass of the sand? (3 marks)

SECTION B

Answer all questions in this section.

13. (a) Differentiate between displacement and speed. (2 marks)

.....
.....
.....

- b) The figure below shows velocity time graphs for two objects A and B drawn on the same axes.

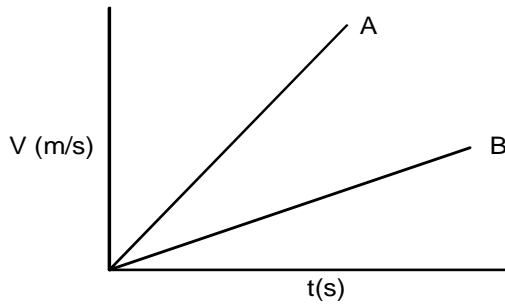

State with a reason which of the two objects stops in a shorter distance when the same size of force is applied against each given that they are of equal masses. (2 marks)

.....
.....

- c) An object moving at 26m/s starts to accelerate at 2m/s² so that its velocity becomes 48m/s.
Find
i) The distance moved during this acceleration. (3 marks)

ii) The object is now braked so that it comes to rest in a time of 12 seconds. Find the braking force if its mass was 27000g. (3 marks)

d) A body moving with uniform acceleration of 10 m/s^2 covers a distance of 320 m. if its initial velocity was 60 m/s. Calculate its final velocity. (3 marks)

14. a)(i) Distinguish between streamline flow and turbulent flow. (2marks)

.....
.....

(ii) A boat travelling at a very high speed is likely to be dragged into a ship travelling in the opposite direction at high speed. Explain this observation. (1mark)

.....
.....

(i) The figure below shows a non-viscous fluid that is not compressible moving through a tube of varied cross-sectional area

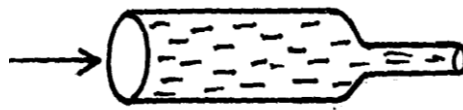

If the area of the narrower end is 0.05 m^2 . calculate the diameter of the wider region. (3 marks)

15. a) i) State Newton's second law of motion. (1 mark)

.....
.....

ii) Explain why a high jumper flexes his knees when landing on the ground. (1 mark)

.....
.....

b) A ball of mass 100g is dropped from a height 1.25m above the ground surface. It rebounds to a height of 1.1m.

Calculate

i) Velocity of the ball before impact. (3 marks)

ii) Force of impact (take $g = 10\text{N/kg}$) (3 marks)

c) i) Differentiate between elastic and inelastic collision. (1 mark)

.....
.....

ii) A car of mass 800kg collides head on with a truck of mass 5000kg travelling at 40m/s. The car is thrown on to the bonnet of the truck which continues to move after impact at 10m/s in the original direction.

How fast was the car moving? (3 marks)

16. The figure below is a hydraulic jack system.

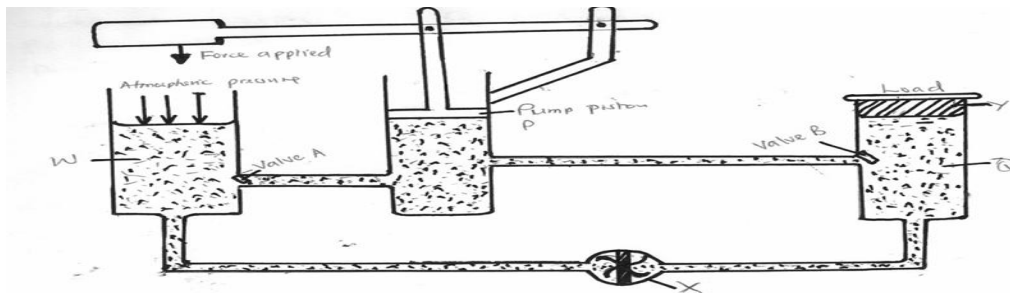

(a) Name the parts labeled W, X and Y (3marks)

.....
.....
.....

(b) Briefly explain how the device may be used to raise a load at the position shown. (3marks)

.....
.....
.....

(c) Part W is left open to the atmosphere as indicated. Explain. (2marks)

.....
.....
.....

(d) State two ways by which the mechanical advantage of the device may be increased. (2marks)

.....
.....
.....

(e) One such hydraulic brake system was used to lift a car whose mass was 1200kg. The cross sectional area of Q was 5000cm^2 and that of P was 5cm^2 . Determine the force exerted on the pump piston (3marks)

17. (a) State HOOKE'S LAW. (1 mark)

.....
.....

b) i) What is a spring constant? (1 mark)

.....
.....

ii) Explain three factors determining spring constant.

(6 marks)

.....

.....

.....

.....

.....

.....

.....

.....

(c) Two identical springs of spring constant 3N/cm are used to support a load of 30N as shown in the figure below. Determine the extension of each spring. (3 marks)

